

## INSTRUCTION MANUAL

### Irritrol<sup>®</sup> 4,6,8 station DC Dual Program

#### INSTALLATION INSTRUCTIONS

Remove the lower cover. Place the unit on the wall using one slot and one fixed hole under the terminal.

#### 9 VOLT VALVE:

A 9 volt, Pulse operated solenoid must be used with this controller. Make sure that the valve you purchased is equipped with the right solenoid. ( 2 wires each with different color)  
Connect the **RED** wire from each solenoid valve to a separate STATION No. terminal.  
Connect the **BLACK** wire from each solenoid valve to the terminal marked "C"- Common.

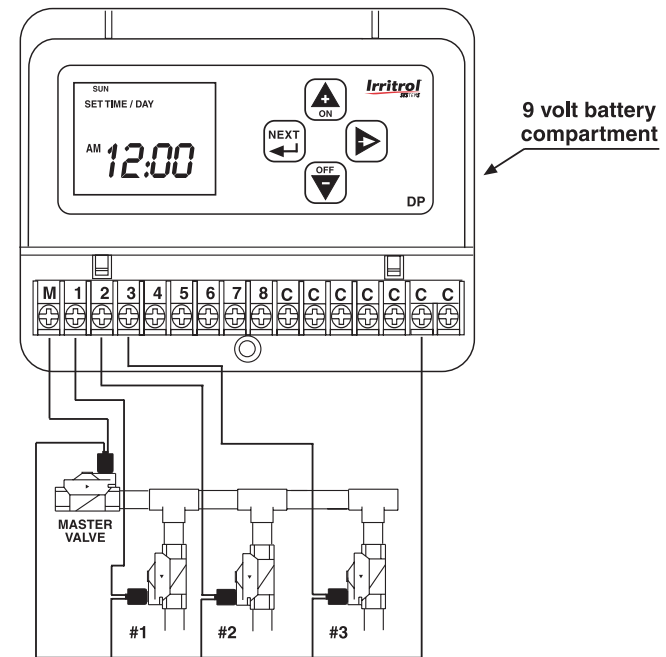

**Connect the wires FIRST before installing the battery. When battery is connected, the controller checks the valves position to make sure they are all in close position!**

To install the battery, press on the drawer located on the right side of the controller, pull it out, place the 9 volt battery inside and push back. **Low battery indication** will start flashing when battery is low. Replace battery.

**IMPORTANT:** A delay of 2-3 sec. between pressing ON or OFF to the actual response of the valve was design to save energy

#### MANUAL

Two MANUAL modes are available:

#### NOTE!

To get to Manual mode from any position, press continuously.

Manual start per station (only that station)

Press to open the station. ( Station Icon will stop flashing )  
Press to turn off the station.

Press to select your next station.

If you leave the station ON, it will close after it's programmed watering time. First priority is watering time program 1, 2nd priority is watering time program 2, and if no watering time was programmed, will open for 2 minuts. After the station is closed, the controller will skip to AUTO mode.

Press to select next manual mode.

Manual start per program - Semi-Auto

In this step, you can turn on all the stations programmed in program 1 or program 2. The valves will open in sequence.

The 1st programmed station in this program will flash.

Press to start the cycle and to terminate it.

Press to select program 2. repeat as in prog.1

Press to advance to AUTO mode.

#### AUTO-RUN/OFF

Will display Time & Day, open station, power failure and OFF.

Press in AUTO mode to stop irrigation.

Press in AUTO mode to resume irrigation.

#### WATER BUDGET

When you wish to either increase or decrease watering time for all stations in a program, you can do it by using percentage scaling. Your current setting of watering time represent 100%.

You can get to Water Budget position from any Watering Time position. Press until you pass all stations and display show **100** and the active stations in that program are flashing.

Press to increase and to decrease the percentage.

EX: If stations in PI are set at 10 minutes runtime and you increase percentage to 150%, they will now run 15 minutes each.

Press to skip to MANUAL mode.

#### PI & PII



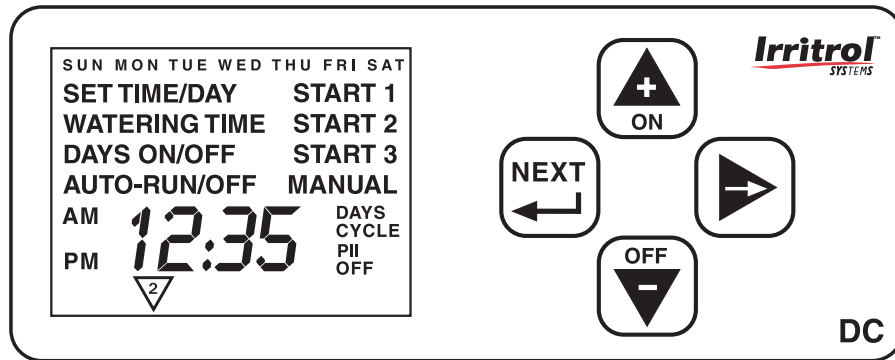

#### IMPORTANT INFORMATION

- The button leads you through the programming steps.
- Auto Return: If within 3 minutes you do not touch any button, the controller will automatically return to Auto mode except from MANUAL mode.
- Quick Digit advance: If you Press or continuously, the digits will advance quickly.
- Reset display back to OFF: If you press and simultaneously and hold for few seconds, the digits displayed will reset back to OFF.
- Program Erase: In Auto Run mode, press and simultaneously until arrow starts to flash. It will flash 5 times to complete Program Erase.

# THE CONTROL PANEL



## The control buttons:

-  "NEXT STEP" Advance to next programming step.
-  Increase TIME & Watering Time. Used also as "ON" for Days ON & Manual ON.
-  Advance Days & station No. In Watering Time position Will lead you to % scaling.
-  Decrease TIME & Watering Time. Used also as "OFF" for Days OFF & Manual OFF.

## Display Icons:

- "Days of the week" - upper line.
- "OFF" flashing - Low Battery
- "Programming steps" - Watering Time, Days On/Off, 3 start times Manual and Auto-Run.
- "24V" - Will flash if command to turn on the station was given during Power Failure.
- "Days Cycle" - Will be ON when programming Days Cycle
- "OFF" - RAIN OFF Icon
-  Station Icon

## Irrigation Program

Irrigation program consists of 3 parameters:

- 1** Watering duration for each station
- 2** Irrigation days
- 3** Program start time

Each station can be assigned to a program by entering Water Time in that program. Stations can be assigned to both programs.

## PROGRAMMING STEPS

**NOTE:** If you press  or  continuously, the digits will advance quickly.

### SET TIME/DAY

After connecting the battery, the controller should display the "SET TIME/DAY" Icon. If not, Press  until it is displayed.

Press  until current day is displayed.

Press  or  to set current time.

Press  to enter watering time.

### **1** WATERING TIME PI

Enter Watering Time to all stations you wish to assign to this program. Each station can be programmed to have different Watering Time.

Press  or  to set the watering time

Press  to select your next station in this program.

Repeat for all the stations.

Press  to advance to next programming step.

### **2** DAYS ON/OFF PI



You can either select the days of the week you wish to water or select days cycle. SU is flashing.

Press  for the days you wish to water.

Press  for the days you wish to skip irrigation.

### DAYS CYCLE PI



Press  until "DAYS CYCLE" is displayed.

Press  or  to select your days cycle.

Notice that two sets of digits are displayed (  ). The right digit will display the selected days cycle while the left digit will display the remaining days to irrigation. If 1 is selected = Every day. 2=Every other day. 3= once every 3 days and so on.

Press  to program the start time.

### **3** START TIME PI

Press  or  to set the time. (Notice the AM & PM)

Press  to set next (2nd) start time.

At the time you selected, the 1st station of Prog. 1 will start watering. Other stations in this program will operate sequentially, one after the other, automatically.

To enter program 2 (PII) Press  and repeat from **1** to **3**.

To skip program 2, Press  continuously until you reach Manual.